

Electromagnetic Induction and Alternating

Question1

Let us consider two solenoids A and B, made from same magnetic material of relative permeability μ_r and equal area of cross-section. Length of A is twice that of B and the number of turns per unit length in A is half that of B. The ratio of self inductances of the two solenoids, $L_A : L_B$ is

[NEET 2024 Re]

Options:

- A.
1 : 2
- B.
2 : 1
- C.
8 : 1
- D.
1 : 8

Answer: A

Solution:

$$L = \mu_0 \mu_r \times n \times A \times N$$
$$L = \mu_0 \mu_r n \times A \times \frac{N}{l} \times I$$
$$L = \mu_0 \mu_r \times n^2 \times A \times l \Rightarrow L \propto n^2 l$$
$$\Rightarrow \frac{L_A}{L_B} = \frac{n_A^2}{n_B^2} \times \frac{l_A}{l_B}$$
$$\Rightarrow \frac{L_A}{L_B} = \frac{1}{4} \times 2 = \frac{1}{2}$$

Question2

In the circuit shown below, the inductance L is connected to an ac source. The current flowing in the circuit is $I = I_0 \sin \omega t$. The voltage



drop (V_L) across L is

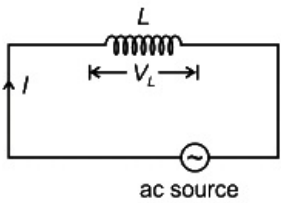

[NEET 2024 Re]

Options:

A.

$$\omega LI_0 \sin \omega t$$

B.

$$\frac{I_0}{\omega L} \sin \omega t$$

C.

$$\frac{I_0}{\omega L} \cos \omega t$$

D.

$$\omega LI_0 \cos \omega t$$

Answer: D

Solution:

V_L leads current I by $\frac{\pi}{2}$

$$\therefore V_L = V_0 \sin \left(\omega t + \frac{\pi}{2} \right) \quad (\because I = I_0 \sin \omega t)$$

$$V_0 = I_0 X_L$$

$$\Rightarrow V_L = I_0 X_L \cos(\omega t) = 10\omega L \cos(\omega t)$$

Question3

A step up transformer is connected to an ac mains supply of 220V to operate at 11000V, 88 watt. The current in the secondary circuit, ignoring the power loss in the transformer, is

[NEET 2024 Re]

Options:

A.

8 mA

B.

4 mA

C.

0.4A

D.

4A

Answer: A**Solution:**

In secondary circuit, $P = Vi$

$$\Rightarrow 88 = 11000i$$

$$\Rightarrow i = \frac{88}{11 \times 10^3} = 8 \times 10^{-3} \text{ A}$$

$$\Rightarrow i = 8 \text{ mA}$$

Question4

The amplitude of the charge oscillating in a circuit decreases exponentially as $Q = Q_0 e^{-Rv^2L}$, where Q_0 is the charge at $t = 0$ s . The time at which charge amplitude decreases to $0.50 Q_0$ is nearly:

[Given that $R = 1.5\Omega$, $L = 12$ mH, $\ln(2) = 0.693$]

[NEET 2024 Re]

Options:

A.

19.01 ms

B.

11.09 ms

C.

19.01 s

D.

11.09 s



Answer: B

Solution:

$$\text{Given } Q = Q_0 e^{-RU/L}$$

$$R = 1.5\Omega, L = 12 \text{ mH}, \ln(2) = 0.693$$

$$Q = 0.5Q_0, t = ?$$

$$0.5Q_0 = Q_0 e^{-Rt/2L}$$

$$\Rightarrow \frac{1}{2} = e^{-Rt/2L}$$

Taking log on both sides

$$\ln\left(\frac{1}{2}\right) = \ln e^{-Rt/2L}$$

$$\Rightarrow \ln 2 = \frac{Rt}{2L}$$

$$t = \frac{2L \ln 2}{R} = \frac{2 \times 12 \times 10^{-3} \times 0.693}{1.5}$$

$$t = 11.09 \text{ ms}$$

Question5

In an ideal transformer, the turns ratio is $\frac{N_p}{N_s} = \frac{1}{2}$. The ratio $V_s : V_p$ is equal to (the symbols carry their usual meaning) :

[NEET 2024]

Options:

A.

1 : 2

B.

2 : 1

C.

1 : 1

D.

1 : 4

Answer: B

Solution:

According to transformer ratio,

$$\frac{V_S}{V_P} = \frac{N_S}{N_P} = 2 : 1$$

Question6

A $10\mu\text{F}$ capacitor is connected to a $210\text{V}, 50\text{Hz}$ source as shown in figure. The peak current in the circuit is nearly ($\pi = 3.14$) :

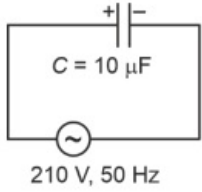

[NEET 2024]

Options:

- A.
0.58A
- B.
0.93A
- C.
1.20A
- D.
0.35A

Answer: B

Solution:

$$\text{Capacitive Reactance } X_C = \frac{1}{\omega C} = \frac{1}{2\pi f C} = \frac{1}{2 \times 3.14 \times 50 \times 10 \times 10^{-6}}$$

$$= \frac{1000}{3.14}$$

$$V_{\text{rms}} = 210\text{V}$$

$$i_{\text{rms}} = \frac{V_{\text{rms}}}{X_C} = \frac{210}{X_C}$$

$$\text{Peak current} = \sqrt{2} i_{\text{rms}} = \sqrt{2} \times \frac{210}{1000} \times 3.14 = 0.932$$

$$= 0.93\text{A}$$

Question7

The net magnetic flux through any closed surface is

[NEET 2023]

Options:

A.

Positive

B.

Infinity

C.

Negative

D.

Zero

Answer: D

Solution:

$\oint \vec{B} \cdot d\vec{s} = \text{zero}$ Magnetic monopole doesn't exist. Hence net magnetic flux through any closed surface is zero.

Question8

The magnetic energy stored in an inductor of inductance $4\mu\text{H}$ carrying a current of 2A is

[NEET 2023]

Options:

A.

4mJ

B.

8mJ

C.

$8\mu\text{J}$

D.

$4\mu\text{J}$

Answer: C

Solution:

Magnetic energy stored in an inductor

$$\begin{aligned}U &= \frac{1}{2}Li^2 \\&= \frac{1}{2} \times 4 \times 10^{-6} \times (2)^2 \\&= 8 \times 10^{-6} \text{J} \\U &= 8\mu\text{J}\end{aligned}$$

Question9

In a series LCR circuit, the inductance L is 10mH, capacitance C is 1μF and resistance R is 100Ω. The frequency at which resonance occurs is

[NEET 2023]

Options:

A.

15.9kHz

B.

1.59rad/ s

C.

1.59kHz

D.

15.9rad/ s

Answer: C

Solution:

$$\begin{aligned}\text{Sol. For resonance frequency} &= \frac{1}{2\pi\sqrt{LC}} \\ \Rightarrow f &= \frac{1}{2 \times \pi \times \sqrt{10 \times 10^{-3} \times 1 \times 10^{-6}}} = \frac{10^4}{2\pi} \\ &= 1.591 \times 10^3 \\ &= 1.591 \text{ kHz}\end{aligned}$$

Question10

A 12V,60W lamp is connected to the secondary of a step-down

transformer, whose primary is connected to ac mains of 220V. Assuming the transformer to be ideal, what is the current in the primary winding?

[NEET 2023]

Options:

A.

2.7A

B.

3.7A

C.

0.37A

D.

0.27A

Answer: D

Solution:

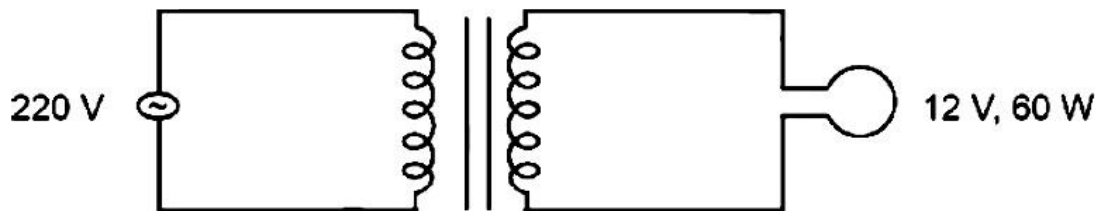

For ideal transformer

$$P_{\text{input}} = P_{\text{output}}$$

$$(VI)_{\text{in}} = 60$$

$$220 \times I = 60$$

$$I = 0.27\text{A}$$

Question 11

The net impedance of circuit (as shown in figure) will be

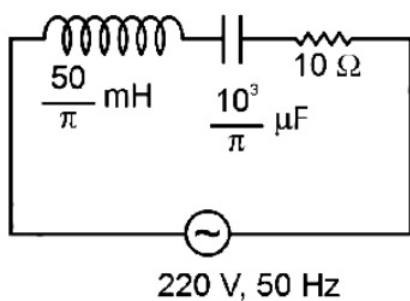

[NEET 2023 mpr]

Options:

A.

15Ω

B.

5√5Ω

C.

25Ω

D.

10√2Ω

Answer: B

Solution:

$$L = \frac{50}{\pi} \text{ mH}$$

$$X_L = 2\pi \times 50 \times \frac{50}{\pi} \times 10^{-3} = 5\Omega$$

$$C = \frac{10^3}{\pi} \times 10^{-6}$$

$$X_C = \frac{1 \times \pi}{2\pi \times 50 \times 10^3 \times 10^{-6}} = \frac{10^3}{100} = 10\Omega$$

$$Z = \sqrt{(X_C - X_L)^2 + R^2}$$

$$Z = \sqrt{(10 - 5)^2 + 10^2} = \sqrt{125} = 5\sqrt{5}\Omega$$

Question12

An ac source is connected in the given circuit. The value of ϕ will be :

$$V = 220\sin(100\pi t + \phi) \text{ volt}$$

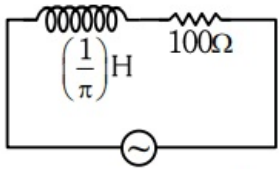

$$V = 220\sin(100\pi t + \phi) \text{ volt}$$

[NEET 2023 mpr]

Options:

A.

60°

B.

90°

C.

30°

D.

45°

Answer: D

Solution:

$$\tan \phi = \frac{X_L}{R}$$

$$X_L = \omega l = 100\pi \times \frac{1}{\pi} = 100\Omega$$

$$R = 100\Omega$$

$$\tan \phi = \frac{100}{100} = 1$$

$$\phi = 45^\circ$$

Question13

If Z_1 and Z_2 are the impedances of the given circuits (a) and (b) as shown in figures, then choose the correct option

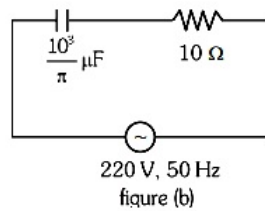
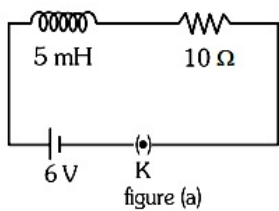

[NEET 2023 mpr]

Options:

A.

$$Z_1 < Z_2$$

B.

$$Z_1 = Z_2$$

C.

$$Z_1 + Z_2 = 20\Omega$$

D.

$$Z_1 > Z_2$$



Answer: A

Solution:

$$Z_1 = \sqrt{X_L^2 + R^2} \quad X_L = 0 \text{ (D.C. circuit)}$$

$$Z_1 = 10\Omega$$

$$Z_2 = \sqrt{X_C^2 + R^2}$$

$$X_C = \frac{1}{2\pi \times 50 \times \frac{10^3}{\pi} \times 10^{-6}} = 10\Omega$$

$$Z_2 = \sqrt{(10)^2 + (10)^2} \\ = 10\sqrt{2}$$

$$Z_1 < Z_2$$

Question14

The maximum power is dissipated for an ac in a/an:

[NEET 2023 mpr]

Options:

A.

resistive circuit

B.

LC circuit

C.

inductive circuit

D.

capacitive circuit

Answer: A

Solution:

Solution:

Power dissipated is maximum of purely resistive circuit.

Question15

An emf is generated by an ac generator having 100 turn coil, of loop area 1m². The coil rotates at a speed of one revolution per second and

placed in a uniform magnetic field of 0.05T perpendicular to the axis of rotation of the coil. The maximum value of emf is :-

[NEET 2023 mpr]

Options:

A.

3.14V

B.

31.4V

C.

62.8V

D.

6.28V

Answer: B

Solution:

$$\omega = 2\pi \frac{\text{rad}}{\text{sec}}$$

$$E_{\text{max}} = NBA\omega$$

$$= 100 \times 0.05 \times 1 \times 2\pi$$

$$= 10 \times \pi$$

$$= 31.4\text{V}$$

Question16

For very high frequencies, the effective impedance of the circuit (shown in the figure) will be :-

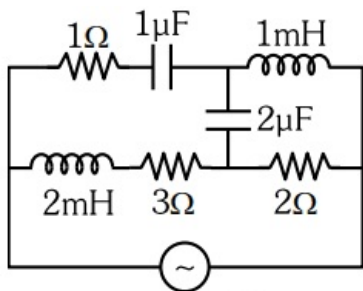

[NEET 2023 mpr]

Options:

A.



4Ω

B.

6Ω

C.

1Ω

D.

3Ω

Answer: D

Solution:

as frequency is very high

$$X_C \approx 0$$

$$X_L \rightarrow \infty$$

Effective circuit will be

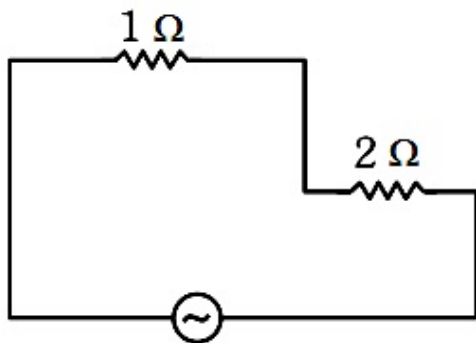

Effective impedance of circuit will be = 3Ω

Question17

The magnetic flux linked to a circular coil of radius R is:

$$\phi = 2t^3 + 4t^2 + 2t + 5 \text{ Wb}$$

The magnitude of induced emf in the coil at t = 5s is:

[NEET Re-2022]

Options:

A. 192V

B. 108V

C. 197V

D. 150V

Answer: A

Solution:

$$\varphi = 2t^3 + 4t^2 + 2t + 5$$

$$|e| = \left| \frac{d\varphi}{dt} \right| = \frac{d}{dt}[2t^3 + 4t^2 + 2t + 5] = 6t^2 + 8t + 2$$

$$e(t) = 6t^2 + 8t + 2$$

$$e(t=5) = 6(5)^2 + 8(5) + 2$$

$$= 150 + 40 + 2$$

$$= 192\text{V}$$

Question 18

Given below are two statements.

Statement I:

In an ac circuit, the current through a capacitor leads the voltage across it.

Statement II:

In a.c circuits containing pure capacitance only, the phase difference between the current and the voltage is π .

In the light of the above statements, choose the most appropriate answer from the options given below

[NEET Re-2022]

Options:

- A. Statement I is incorrect but Statement II is correct
- B. Both Statement and Statement II are correct
- C. Both Statement I and Statement II are incorrect
- D. Statement I is correct but Statement II is incorrect

Answer: D

Solution:

Solution:

In AC circuit current through the capacitor leads the potential difference across it by a phase $\pi/2$.

Question 19

An inductor of inductance 2 mH is connected to a 220V, 50 Hz a.c. source. Let the inductive reactance in the circuit is X_1 . If a 220V dc source replaces the ac source in the circuit, then the inductive reactance in the circuit is X_2 . X_1 and X_2 respectively are

[NEET Re-2022]

Options:

- A. 0.628Ω , infinity
- B. 6.28Ω , zero
- C. 6.28Ω , infinity
- D. 0.628Ω , zero

Answer: D**Solution:****Solution:**

Given $L = 2mH$, $f = 50\text{ Hz}$

when A. C. source is applied

$$X_1 = \omega L = 2\pi fL$$

$$= 2\pi \times 50 \times 2 \times 10^{-3}$$

$$= .628\Omega$$

when D. C. source is applied

$$X_2 = \omega L = 2\pi fL$$

$$(\because f = 0)$$

$$X_2 = 0$$

Question20

A standard filament lamp consumes 100W when connected to 200V ac mains supply. The peak current through the bulb will be: [NEET Re-2022]

Options:

- A. 2A
- B. 0.707A
- C. 1A
- D. 1.414

Answer: B**Solution:**

Given, $P = 100\text{W}$

$$V_{\text{rms}} = 200\text{V}$$

$$i_{\text{rms}} = \frac{P}{V_{\text{rms}}} = \frac{1}{2}$$

$$i_0 = i_{\text{rms}} \times \sqrt{2} = \frac{1}{\sqrt{2}}$$

$$i_0 = 0.707\text{A}$$

Question21

The peak voltage of the ac source is equal to [NEET-2022]

Options:

- A. The value of voltage supplied to the circuit
- B. The rms value of the ac source
- C. $\sqrt{2}$ times the rms value of the ac source
- D. $1 / \sqrt{2}$ times the rms value of the ac source

Answer: C

Solution:

Solution:

We know,

$$\text{RMS value of A.C. } E_{\text{rms}} = \frac{E_0}{\sqrt{2}}$$

$$E_0 = \sqrt{2}E_{\text{rms}}$$

Question22

A square loop of side 1m and resistance 1Ω is placed in a magnetic field of 0.5T . If the plane of loop is perpendicular to the direction of magnetic field, the magnetic flux through the loop is [NEET-2022]

Options:

- A. 2 weber
- B. 0.5 weber
- C. 1 weber

©



D. Zero weber

Answer: B

Solution:

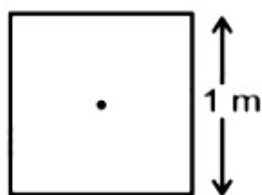

$$\text{Magnetic flux } (\phi_B) = \vec{B} \cdot \vec{A}$$

\vec{B} and \vec{A} are in same direction, therefore

$$\phi_B = B \cdot A = 0.5 \times 1^2$$

$$= 0.5 \text{ Wb}$$

Question23

A series LCR circuit with inductance 10H , capacitance 10 μ F , resistance 50 Ω is connected to an ac source of voltage, $V = 200 \sin(100t)$ volt. If the resonant frequency of the LCR circuit is ν_0 and the frequency of the ac source is ν , then
[NEET-2022]

Options:

A. $\nu_0 = \nu = 50 \text{ Hz}$

B. $\nu_0 = \nu = \frac{50}{\pi} \text{ Hz}$

C. $\nu_0 = \frac{50}{\pi} \text{ Hz}$, $\nu = 50 \text{ Hz}$

D. $\nu = 100 \text{ Hz}$; $\nu_0 = \frac{100}{\pi} \text{ Hz}$

Answer: B

Solution:

Solution:

$$\omega L = \frac{1}{\omega C}$$

$$\omega = \frac{1}{\sqrt{LC}} = \frac{1}{\sqrt{10 \times 10 \times 10^{-6}}}$$

$$\omega = 100$$

$$\omega = 2\pi f \Rightarrow f = \frac{\omega}{2\pi}$$

$$v_0 = f_0 = \frac{100}{2\pi} = \frac{50}{\pi} \text{ Hz}, \quad \omega = 100$$

$$v = f = \frac{100}{2\pi} = \frac{50}{\pi}$$

Question24

A big circular coil of 1000 turns and average radius 10m is rotating about its horizontal diameter at 2 rad^{-1} . If the vertical component of earth's magnetic field at that place is $2 \times 10^{-5} \text{ T}$ and electrical resistance of the coil is 12.56Ω , then the maximum induced current in the coil will be

[NEET-2022]

Options:

A. 0.25A

B. 1.5A

C. 1A

D. 2A

Answer: C

Solution:

$$\varphi_B = NBA \cos \omega t$$

$$\varepsilon = \frac{-d\varphi_B}{dt} = -NBA\omega(-\sin \omega t)$$

$$\varepsilon = NBA\omega \sin \omega t$$

$$i_{\max} = \frac{\varepsilon_{\max}}{R} = \frac{NBA\omega}{R}$$

$$= \frac{1000 \times 2 \times 10^{-5} \times \pi(10)^2 \times 2}{12.56}$$

$$= 1A$$

Question25

An inductor of inductance L , a capacitor of capacitance C and a resistor of resistance ' R ' are connected in series to an ac source of potential difference ' V ' volts as shown in figure.

Potential difference across L , C and R is $40V$, $10V$ and $40V$, respectively. The amplitude of current flowing through angle $C R$ series circuit is $10\sqrt{2}A$. The impedance of the circuit is

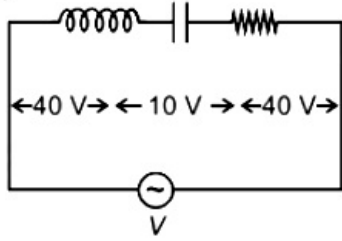

[NEET 2021]

Options:

- A. $4\sqrt{2}\Omega$
- B. $\frac{5}{\sqrt{2}}\Omega$
- C. 4Ω
- D. 5Ω

Answer: D

Solution:

$$V_L = 40 \text{ volt}$$

$$V_R = 40 \text{ volt}$$

$$V_C = 10 \text{ volt}$$

$$\begin{aligned} \text{Now, } V_{\text{RMS}} &= \sqrt{V_R^2 + (V_L - V_C)^2} \\ &= \sqrt{(40)^2 + (40 - 10)^2} = 50V \end{aligned}$$

$$I_{\text{RMS}} = \frac{I_0}{\sqrt{2}} = \frac{10\sqrt{2}}{\sqrt{2}} = 10A$$

$$\therefore V_{\text{RMS}} = I_{\text{RMS}} \times Z$$

$$\therefore Z = \frac{V_{\text{RMS}}}{I_{\text{RMS}}} = \frac{50}{10} = 5\Omega$$

Question26

A step down transformer connected to an ac mains supply of $220V$ is made to operate at $11V$, $44W$ lamp. Ignoring power losses in the transformer, what is the current in the primary circuit?

[NEET 2021]

Options:

- A. 0.2 A
- B. 0.4 A
- C. 2 A
- D. 4 A

Answer: A**Solution:**

In ideal transformer:
 Input power = Output power
 $\Rightarrow V_P I_P = V_S I_S = \text{Given power}$
 $\Rightarrow 220 \times I_P = 44$
 $\Rightarrow I_P = 0.2\text{A}$

Question27

A series LCR circuit containing 5.0 H inductor, 80 μF capacitor and 40 resistor is connected to 230 V variable frequency ac source. The angular frequencies of the source at which power transferred to the circuit is half the power at the resonant angular frequency are likely to be [NEET 2021]

Options:

- A. 25 rad/s and 75 rad/s
- B. 50 rad/s and 25 rad/s
- C. 46 rad/s and 54 rad/s
- D. 42 rad/s and 58 rad/s

Answer: C**Solution:****Solution:**

The resonance frequency of LCR series circuit is given as $\omega_0 = \frac{1}{\sqrt{LC}} = \frac{1}{\sqrt{5 \times 80 \times 10^{-6}}} = 50\text{rad / s}$ Now half power

frequencies are given as

$$\omega = \omega_0 \pm \frac{R}{2L}$$

$$\text{i.e. } \omega_L = 50 - \frac{40}{2 \times 5} = 46 \text{ rad/s}$$

$$\omega_H = 50 + \frac{40}{2 \times 5} = 54\text{rad/s}$$



Question28

Two conducting circular loops of radii R_1 and R_2 are placed in the same plane with their centres coinciding. If $R_1 \gg R_2$, the mutual inductance M between them will be directly proportional to [NEET 2021]

Options:

A. $\frac{R_1}{R_2}$

B. $\frac{R_2}{R_1}$

C. $\frac{R_1^2}{R_2}$

D. $\frac{R_2^2}{R_1}$

Answer: D

Solution:

Solution:

Two concentric coils are of radius R_1 and R_2 as shown

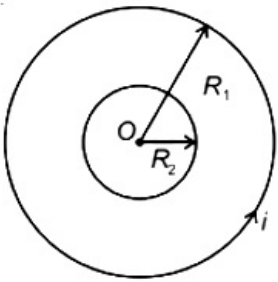

Let current in outer loop be i

$$\text{Magnetic field at centre} = B = \frac{\mu_0 i}{2R_1}$$

$$\text{Magnetic flux through inner coil} = B \times \pi R_2^2$$

$$\phi = \frac{\mu_0 i}{2R_1} \times \pi R_2^2$$

$$\phi = \frac{\mu_0 i}{2} \times \frac{\pi R_2^2}{R_1}$$

as per definition, $\phi = M i$

$$\Rightarrow M = \left(\frac{\mu_0 \pi}{2} \right) \frac{R_2^2}{R_1}$$

$$\therefore M \propto \frac{R_2^2}{R_1}$$

Question29

A $40\mu\text{F}$ capacitor is connected to a 200V , 50Hz ac supply. The rms

value of the current in the circuit is, nearly:
[2020]

Options:

- A. 2.05A
- B. 2.5A
- C. 25.1A
- D. 1.7A

Answer: B

Solution:

(b) Given :

Capacitance, $C = 40\mu\text{F} = 40 \times 10^{-6}\text{F}$

Frequency, $f = 50\text{Hz}$

$\therefore \omega = 2\pi f = 100\pi$

$$\begin{aligned} \varepsilon_{\text{rms}} &= 200\text{V} \therefore I_{\text{rms}} = \frac{\varepsilon_{\text{rms}}}{X_C} = \frac{\varepsilon_{\text{rms}}}{\frac{1}{C\omega}} \\ &= 200 \times 40 \times 10^{-6} \times 2\pi \times 50 = 2.5\text{A} \end{aligned}$$

Question30

A series LCR circuit is connected to an ac voltage source. When L is removed from the circuit, the phase difference between current and voltage is $\frac{\pi}{3}$. If instead C is removed from the circuit, the phase difference is again $\frac{\pi}{3}$ between current and voltage. The power factor of the circuit is:
(2020)

Options:

- A. 0.5
- B. 1.0
- C. -1.0
- D. zero

Answer: B

Solution:



(b) When L is removed,

Phase difference

$$\tan \phi = \frac{|X_C|}{R} = \tan \frac{\pi}{3} = \frac{X_C}{R} \dots\dots\dots (1)$$

When C is removed, Phase difference

$$\tan \phi = \frac{|X_L|}{R} = \tan \frac{\pi}{3} = \frac{X_L}{R} \dots\dots\dots (2)$$

From eqs. (1) and (2), $X_L = X_C$

since, $X_L = X_C$, the circuit is in resonance.

In this case, $Z = R$

$$\therefore \text{Power factor, } \cos \phi = \frac{R}{Z} = 1$$

Question31

In which of the following devices, the eddy current effect is not used? (NEET 2019)

Options:

- A. electric heater
- B. induction furnace
- C. magnetic braking in train
- D. electromagnet

Answer: A

Solution:

Solution:
Electric heater works on the principle of Joule's heating effect.

Question32

A 800 turn coil of effective area 0.05m^2 is kept perpendicular to a magnetic field $5 \times 10^{-5} \text{ T}$. When the plane of the coil is rotated by 90° around any of its coplanar axis in 0.1 s, the emf induced in the coil will be

(NEET 2019)

Options:

- A. 0.02V
- B. 2V

C. 0.2V

D. $2 \times 10^{-3}V$

Answer: A

Solution:

Solution:

Here $N = 800$, $A = 0.05m^2$

$B = 5 \times 10^{-5}T$, $\Delta t = 0.1s$

$$\text{Induced emf, } \varepsilon = -\frac{\Delta\phi}{\Delta t} = -\frac{(\phi_f - \phi_i)}{\Delta t}$$

$$\phi_i = N (\vec{B} \cdot \vec{A}) = 800 \times 5 \times 10^{-5} \times 0.05 \times \cos 0^\circ$$

$$= 2 \times 10^{-3}T m^2$$

$$\phi_f = 0$$

$$\therefore \varepsilon = \frac{-(0 - 2 \times 10^{-3})}{0.1} = 2 \times 10^{-2}V = 0.02V$$

Question33

A circuit when connected to an AC source of 12V gives a current of 0.2A. The same circuit when connected to a DC source of 12V, gives a current of 0.4A. The circuit is (OD NEET 2019)

Options:

A. series LR

B. series RC

C. series LC

D. series LCR

Answer: A

Solution:

Solution:

When circuit is connected to an AC source of 12V, gives a current of 0.2A.

$$\therefore \text{Impedance, } Z = \frac{12}{0.2} = 60\Omega$$

When the same circuit is connected to a DC source of 12V, gives a current of 0.4A.

$$\therefore \text{Resistance, } R = \frac{12}{0.4} = 30\Omega$$

$$\text{As, power factor, } \cos \phi = \frac{R}{Z} = \frac{30}{60} = \frac{1}{2} = \cos 60^\circ$$

$\Rightarrow \phi = 60^\circ$, i.e., current lags behind the emf.

So, we can conclude that the circuit is a series LR.

©



Question34

A cycle wheel of radius 0.5m is rotated with constant angular velocity of 10rad / s in a region of magnetic field of 0.1T which is perpendicular to the plane of the wheel. The EMF generated between its centre and the rim is,
(OD NEET 2019)

Options:

- A. 0.25V
- B. 0.125V
- C. 0.5V
- D. zero

Answer: B

Solution:

Solution:

Here, given, $B = 0.1\text{T}$, $r = 0.5\text{m}$

$\omega = 10\text{rad / s}$

So, the emf generated between its centre and rim is, $\varepsilon = \frac{1}{2}B\omega r^2$
 $= \frac{1}{2} \times 0.1 \times 10 \times (0.5)^2 = 0.125\text{V}$

Question35

The magnetic potential energy stored in a certain inductor is 25mJ , when the current in the inductor is 60mA. This inductor is of inductance
(NEET 2018)

Options:

- A. 0.138H
- B. 138.88H
- C. 1.389H
- D. 13.89H

Answer: D

Solution:



Magnetic potential energy stored in an inductor is given by

$$U = \frac{1}{2}LI^2 \Rightarrow 25 \times 10^{-3} = \frac{1}{2} \times L \times (60 \times 10^{-3})^2$$

$$L = \frac{25 \times 2 \times 10^6 \times 10^{-3}}{3600} = \frac{500}{36} = 13.89\text{H}$$

Question36

An inductor 20mH , a capacitor 100μF and a resistor 50Ω are connected in series across a source of emf, $V = 10 \sin 314t$. The power loss in the circuit is (NEET 2018)

Options:

- A. 0.79W
- B. 0.43W
- C. 2.74W
- D. 1.13W

Answer: A

Solution:

Solution:

Impedance Z in an ac circuit is $Z = \sqrt{R^2 + (X_C - X_L)^2}$; where $X_C =$ capacitive reactance and $X_L =$ inductive reactance.

Also $X_C = \frac{1}{\omega C}$ and $X_L = \omega L$

$$\therefore Z = \sqrt{(50)^2 + \left(\frac{1}{314 \times 100 \times 10^{-6}} - 314 \times 20 \times 10^{-3} \right)^2}$$

or $Z = 56\Omega$

The power loss in the circuit is $P_{av} = \left(\frac{V_{rms}}{Z} \right)^2 R$

$$\therefore P_{av} = \left(\frac{10}{(\sqrt{2})56} \right)^2 \times 50 = 0.79\text{W}$$

Question37

A long solenoid of diameter 0.1 m has 2×10^4 turns per metre. At the centre of the solenoid, a coil of 100 turns and radius 0.01 m is placed with its axis coinciding with the solenoid axis. The current in the solenoid reduces at a constant rate to 0 A from 4 A in 0.05 s. If the resistance of the coil is $10\pi^2\Omega$, the total charge flowing through the coil during this time is (2017 NEET)

Options:

- A. $16 \mu\text{C}$
- B. $32 \mu\text{C}$
- C. $16 \pi \mu\text{C}$
- D. $32 \pi \mu\text{C}$

Answer: B**Solution:****Solution:**

Given $n = 2 \times 10^4$; $I = 4\text{A}$

Initially $I = 0\text{A}$

$\therefore B_i = 0$ or $\phi_i = 0$

Finally, the magnetic field at the centre of the solenoid is given as

$$B_f = \mu_0 n I = 4\pi \times 10^{-7} \times 2 \times 10^4 \times 4 = 32\pi \times 10^{-3}\text{T}$$

Final magnetic flux through the coil is given as

$$\phi_f = N B A = 100 \times 32\pi \times 10^{-3} \times \pi \times (0.01)^2$$

$$\phi_f = 32\pi^2 \times 10^{-5}\text{T m}^2$$

$$\text{Induced charge, } q = \frac{|\Delta\phi|}{R} = \frac{|\phi_f - \phi_i|}{R} = \frac{32\pi^2 \times 10^{-5}}{10\pi^2}$$

$$= 32 \times 10^{-6}\text{C} = 32\mu\text{C}$$

Question38

Figure shows a circuit that contains three identical resistors with resistance $R = 9.0\Omega$ each, two identical inductors with inductance $L = 2.0 \text{ mH}$ each, and an ideal battery with emf $\varepsilon = 18\text{V}$. The current i through the battery just after the switch closed is

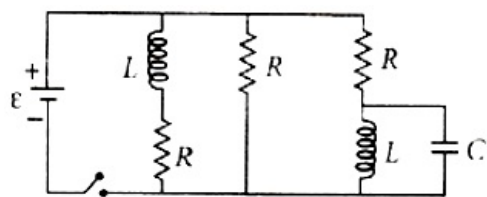
**(2017 NEET)****Options:**

- A. 0.2 A
- B. none of the above
- C. 0 ampere
- D. 2 mA

Answer: B**Solution:**

At time, $t=0$ i.e., when switch is closed, inductor in the circuit provides very high resistance (open circuit) while capacitor starts charging with maximum current (low resistance).

Equivalent circuit of the given circuit

Current drawn from battery,

$$i = \frac{\varepsilon}{\left(\frac{R}{2}\right)} = \frac{2\varepsilon}{R} = \frac{2 \times 18}{9} = 4A$$

Question39

An inductor 20 mH, a capacitor 50 μ F and a resistor 40 Ω are connected in series across a source of emf $V = 10\sin 340t$. The power loss in A.C. circuit is (2016 NEET Phase-1)

Options:

- A. 0.76 W
- B. 0.89 W
- C. 0.51 W
- D. 0.67 W

Answer: C

Solution:

Here, $L = 20\text{mH} = 20 \times 10^{-3}\text{H}$.

$C = 50\mu\text{F} = 50 \times 10^{-6}\text{F}$

$R = 40\Omega$, $V = 10\sin 340t = V_0 \sin \omega t$

$\omega = 340\text{rad s}^{-1}$, $V_0 = 10\text{V}$

$X_L = \omega L = 340 \times 20 \times 10^{-3} = 6.8\Omega$

$X_C = \frac{1}{\omega C} = \frac{1}{340 \times 50 \times 10^{-6}} = \frac{10^4}{34 \times 5} = 58.82\Omega$

$Z = \sqrt{R^2 + (X_C - X_L)^2}$

$= \sqrt{(40)^2 + (58.82 - 6.8)^2}$

$= \sqrt{(40)^2 + (52.02)^2} = 65.62\Omega$

The peak current in the circuit is

$I_0 = \frac{V_0}{Z} = \frac{10}{65.62}\text{A}$, $\cos\phi = \frac{R}{Z} = \left(\frac{40}{65.62}\right)$

Power loss in A.C. circuit

$= V_{\text{rms}} I_{\text{rms}} \cos\phi = \frac{1}{2} V_0 I_0 \cos\phi$

$\frac{1}{2} \times 10 \times \frac{10}{65.62} \times \frac{40}{65.62} = 0.46\text{W}$

Question40

**A small signal voltage $V(t) = V_0 \sin \omega t$ is applied across an ideal capacitor C
(2016 NEET Phase-I)**

Options:

- A. Current $I(t)$ is in phase with voltage $V(t)$.
- B. Current $I(t)$ leads voltage $V(t)$ by 180° .
- C. Current $I(t)$, lags voltage $V(t)$ by 90°
- D. Over a full cycle the capacitor C does not consume any energy from the voltage source

Answer: D

Solution:

Solution:

When an ideal capacitor is connected with an ac voltage source, current leads voltage by 90° . Since, energy stored in capacitor during charging is spent in maintaining charge on the capacitor during discharging. Hence over a full cycle the capacitor does not consume any energy from the voltage source.

Question41

**A long solenoid has 1000 turns. When a current of 4 A flows through it, the magnetic flux linked with each turn of the solenoid is $4 \times 10^{-3} \text{W b}$. The self-inductance of the solenoid is
(2016 NEET Phase-I)**

Options:

- A. 2 H
- B. 1 H
- C. 4 H
- D. 3 H

Answer: B

Solution:

Here, $N = 1000$, $I = 4\text{A}$, $\phi_0 = 4 \times 10^{-3} \text{W b}$

Total flux linked with the solenoid $\phi = N \phi_0$

$$= 1000 \times 4 \times 4 \times 10^{-3} \text{W b} = 4 \text{W b}$$

Since $\phi = LI$

\therefore Self-inductance of solenoid,

$$L = \frac{\phi}{I} = \frac{4 \text{W b}}{4 \text{A}} = 1 \text{H}$$

Question42

Which of the following combinations should be selected for better tuning of an L-C-R circuit used for communication ?
(2016 NEET Phase-II)

Options:

A. $R = 20\Omega$, $L = 1.5\text{H}$, $C = 35\mu\text{F}$

B. $R = 25\Omega$, $L = 2.5\text{H}$, $C = 45\mu\text{F}$

C. $R = 15\Omega$, $L = 3.5\text{H}$, $C = 30\mu\text{F}$

D. $R = 25\Omega$, $L = 1.5\text{H}$, $C = 45\mu\text{F}$

Answer: C

Solution:

Quality factor of an L-C-R circuit is given by

$$Q = \frac{1}{R} \sqrt{\frac{L}{C}}$$

$$Q_1 = \frac{1}{20} \sqrt{\frac{1.5}{35 \times 10^{-6}}} = 50 \times \sqrt{\frac{3}{70}} = 10.35$$

$$Q_2 = \frac{1}{25} \times \sqrt{\frac{2.5}{45 \times 10^{-6}}} = 40 \times \sqrt{\frac{5}{90}} = 9.43$$

$$Q_3 = \frac{1}{15} \sqrt{\frac{3.5}{30 \times 10^{-6}}} = \frac{100}{15} \sqrt{\frac{35}{3}} = 22.77$$

$$Q_4 = \frac{1}{25} \times \sqrt{\frac{1.5}{45 \times 10^{-6}}} = \frac{40}{\sqrt{30}} = 7.30$$

Clearly Q_3 is maximum of Q_1 , Q_2 , Q_3 and Q_4

Hence, option (c) should be selected for better tuning of an L-C-R circuit.

Question43

A uniform magnetic field is restricted within a region of radius r . The magnetic field changes with time at a rate $\frac{dB}{dt}$. Loop 1 of radius $R > r$ encloses the region r and loop 2 of radius R is outside the region of magnetic field as shown in the figure. Then the e.m.f. generated is

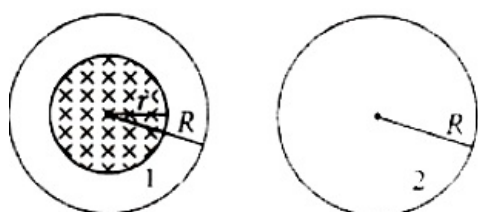

(2016 NEET Phase-II)

Options:

- A. zero in loop 1 and zero in loop 2
- B. $-\frac{d\vec{B}}{dt}\pi r^2$ in loop 1 and $-\frac{d\vec{B}}{dt}\pi r^2$ in loop 2
- C. $\frac{d\vec{B}}{dt}\pi R^2$ in loop 1 and zero in loop 2
- D. $\frac{d\vec{B}}{dt}\pi r^2$ in loop 1 and zero in loop 2

Answer: D

Solution:

Solution:

Emf generated in loop 1,

$$\varepsilon_1 = -\frac{d\phi}{dt} = -\frac{d}{dt}(\vec{B} \cdot \vec{A}) = -\frac{d}{dt}(BA) = -A \times \frac{dB}{dt}$$

$$\varepsilon_1 = -\left(\pi r^2 \frac{dB}{dt}\right)$$

($\because A = \pi r^2$ because $\frac{dB}{dt}$ is restricted upto radius r).

Emf generated in loop 2,

$$\varepsilon_2 = -\frac{d}{dt}(BA) = -\frac{d}{dt}(0 \times A) = 0$$

Question44

The potential differences across the resistance, capacitance and inductance are 80 V, 40 V and 100 V respectively in an L-C-R circuit. The power factor of this circuit is
(2016 NEET Phase-II)

Options:

- A. 0.4
- B. 0.5
- C. 0.8
- D. 1.0

Answer: C

Solution:

Here, $V_R = 80V$, $V_C = 40V$, $V_L = 100V$

©



$$\begin{aligned} \text{Power factor, } \cos\phi &= \frac{R}{Z} \\ &= \frac{V_R}{V} = \frac{V_R}{\sqrt{V_R^2 + (V_L - V_C)^2}} \\ &= \frac{80}{\sqrt{(80)^2 + (100 - 40)^2}} = \frac{80}{100} = 0.8 \end{aligned}$$

Question 45

A resistance 'P' draws power 'P' when connected to an AC source. If an inductance is now placed in series with the resistance, such that the impedance of the circuit becomes 'Z' the power drawn will be (2015)

Options:

- A. $P \left(\frac{R}{Z} \right)$
- B. P
- C. $P \left(\frac{R}{Z} \right)^2$
- D. $P \sqrt{\frac{R}{Z}}$

Answer: C

Solution:

$$\begin{aligned} \text{Case I: } P &= V_{\text{rms}} I_{\text{rms}} \\ &= V_{\text{rms}} \times \frac{V_{\text{rms}}}{R} \\ P &= V_{\text{rms}}^2 \Rightarrow V_{\text{rms}}^2 = PR \dots \dots (i) \end{aligned}$$

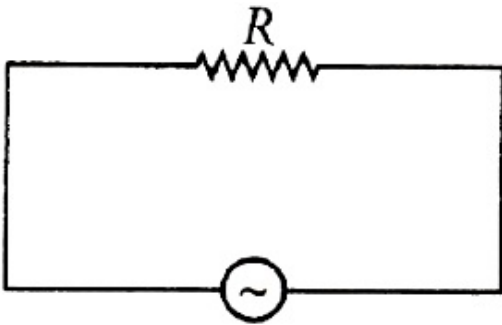

Case II: Power drawn in LR circuit

$$\begin{aligned} P' &= V_{\text{rms}} I_{\text{rms}} \cos\phi = V_{\text{rms}} \times \frac{V_{\text{rms}}}{Z} \times \frac{R}{Z} \\ &= V_{\text{rms}}^2 \frac{R}{Z^2} = PR \times \frac{R}{Z^2} \end{aligned}$$

[Using eqn(i)]

$$P' = P \frac{R^2}{Z^2}$$

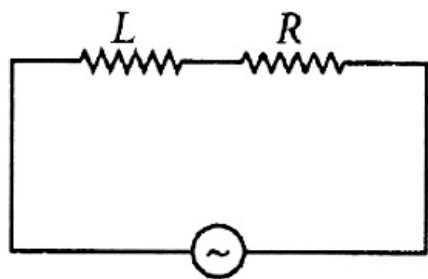

Question46

A conducting square frame of side 'a' and a long straight wire carrying current I are located in the same plane as shown in the figure. The frame moves to the right with a constant velocity 'V'. The emf induced in the frame will be proportional to

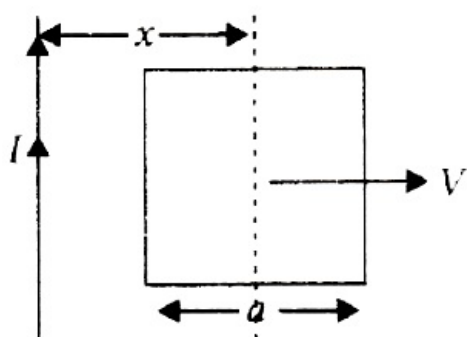

(2015)

Options:

- A. $\frac{1}{(2x + a)^2}$
 B. $\frac{1}{(2x - a)(2x + a)}$
 C. $\frac{1}{x^2}$
 D. $\frac{1}{(2x - a)^2}$

Answer: B

Solution:

Here, PQ = RS = PR = QS = a

Emf induced in the frame

$$\varepsilon = B_1(PQ)V - B_2(RS)V$$

$$= \frac{\mu_0 I}{2\pi \left(x - \frac{a}{2}\right)} aV - \frac{\mu_0 I}{2\pi \left(x + \frac{a}{2}\right)} aV$$

$$= \frac{\mu_0 I}{2\pi} \left[\frac{1}{(2x - a)} - \frac{2}{(2x + a)} \right] aV$$

$$= \frac{\mu_0 I}{2\pi} \times 2 \left[\frac{2a}{(2x - a)(2x + a)} \right]$$

$$\therefore \varepsilon \propto \frac{1}{(2x - a)(2x + a)}$$

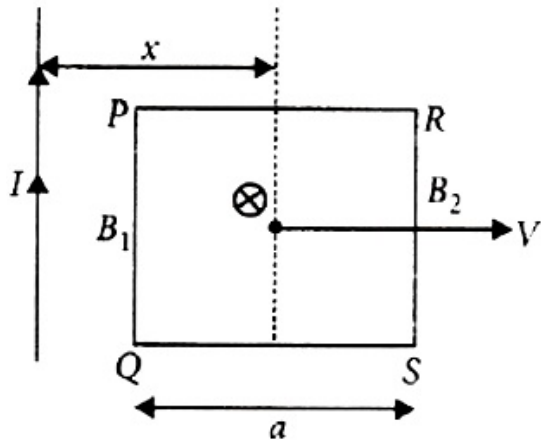

Question 47

A series R-C circuit is connected to an alternating voltage source. Consider two situations

(a) When capacitor is air filled.

(b) When capacitor is mica filled.

Current through resistor is i and voltage across capacitor is V then (2015)

Options:

A. $i_a > i_b$

B. $V_a = V_b$

C. $V < V_b$

D. $V_a > V_b$

Answer: D

Solution:

Solution:

Current through resistor, i = Current in the circuit

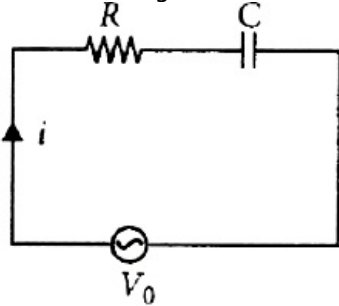

$$i = \frac{V_0}{\sqrt{R^2 + X_c^2}} = \frac{V_0}{\sqrt{R^2 + \left(\frac{1}{\omega C}\right)^2}}$$

Voltage across capacitor, $V = iX_c$

$$V = \frac{V_0}{\sqrt{R^2 + \left(\frac{1}{\omega C}\right)^2}} \times \frac{1}{\omega C} = \frac{V_0}{\sqrt{R^2 \omega^2 C^2 + 1}}$$

As $C_a < C_b$
 $\therefore i_a < i_b$ and $V_a > V_b$

Question48

An electron moves on a straight line path X Y as shown. The abcd is a coil adjacent to the path of electron. What will be the direction of current, if any, induced in the coil?

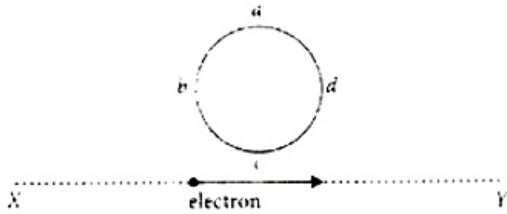

(2015)

Options:

- A. The current will reverse its direction as the electron goes past the coil
- B. No current induced
- C. abcd
- D. adcb

Answer: A

Solution:

Solution:

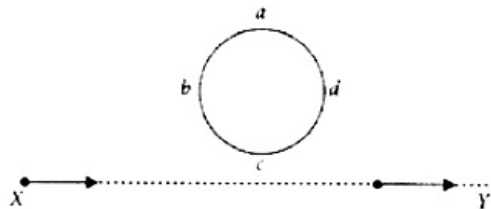

When the electron moves from X to Y, the flux linked with the coil abcd (which is into the page) will first increase and then decrease as the electron passes by. So the induced current in the coil will be first anticlockwise and will reverse its direction (i.e. will become clockwise) as the electron goes past the coil.

Question49

A thin semicircular conducting ring (PQR) of radius r is falling with its plane vertical in a horizontal magnetic field B , as shown in the figure. The potential difference developed across the ring when its speed is v , is

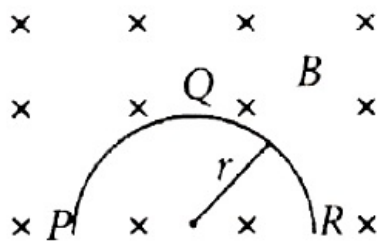

(2014)

Options:

- A. zero
- B. $\frac{Bv\pi r^2}{2}$ and P is at higher potential
- C. πrBv and R is at higher potential
- D. $2rBv$ and R is at higher potential

Answer: D

Solution:

Solution:

Motional emf induced in the semicircular ring PQR is equivalent to the motional emf induced in the imaginary conductor PR.

$$\varepsilon_{PQR} = \varepsilon_{PR} = Bvl = Bv(2r)$$

$$(l = PR = 2r)$$

Therefore, potential difference developed across the ring is $2rBv$ with R is at higher potential.

Question50

A transformer having efficiency of 90% is working on 200 V and 3 kW power supply. If the current in the secondary coil is 6 A, the voltage across the secondary coil and the current in the primary coil respectively are

(2014)

Options:

- A. 300 V, 15 A
- B. 450 V, 15 A
- C. 450 V, 13.5 A
- D. 600 V, 15 A

Answer: B

Solution:

©



Here, Efficiency of the transformer, $\eta = 90\%$

Input power, $P_{in} = 3\text{kW} = 3 \times 10^3\text{W} = 3000\text{W}$

Voltage across the primary coil, $V_p = 200\text{V}$

Current in the secondary coil, $I_s = 6\text{A}$

As $P_{in} = I_p V_p$

\therefore Current in the primary coil,

$$I_p = \frac{P_{in}}{V_p} = \frac{3000\text{W}}{200\text{V}} = 15\text{A}$$

Efficiency of the transformer,

$$\eta = \frac{P_{out}}{P_{in}} = \frac{V_s I_s}{V_p I_p}$$

$$\therefore \frac{90}{100} = \frac{6V_s}{3000} \text{ or } V_s = \frac{90 \times 3000}{100 \times 6} = 450\text{V}$$

Question51

A wire loop is rotated in a magnetic field. The frequency of change of direction of the induced e.m.f. is (2013 NEET)

Options:

- A. four times per revolution
- B. six times per revolution
- C. once per revolution
- D. twice per revolution

Answer: D

Question52

A coil of self-inductance L is connected in series with a bulb B and an AC source. Brightness of the bulb decreases when (2013 NEET)

Options:

- A. a capacitance of reactance $X_C = X_L$ is included in the same circuit.
- B. an iron rod is inserted in the coil.
- C. frequency of the AC source is decreased.
- D. number of turns in the coil is reduced.



Answer: B

Solution:

The situation is as shown in the figure.

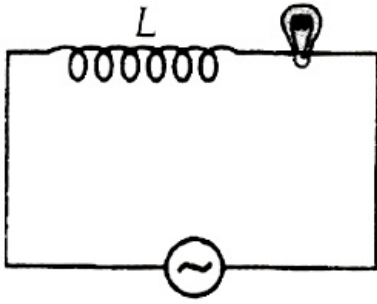

As the iron rod is inserted, the magnetic field inside the coil magnetizes the iron increasing the magnetic field inside it. Hence, the inductance of the coil increases. Consequently, the inductive reactance of the coil increases. As a result, a larger fraction of the applied AC voltage appears across the inductor, leaving less voltage across the bulb. Therefore, the brightness of the light bulb decreases.

Question53

In an electrical circuit, R, L, C and ac voltage source are all connected in series. When L is removed from the circuit, the phase difference between the voltage and the current in the circuit is $\frac{\pi}{3}$. If instead, C is removed from the circuit, the phase difference is again $\frac{\pi}{3}$. The power factor of the circuit is (2012)

Options:

- A. $\frac{1}{2}$
- B. $\frac{1}{\sqrt{2}}$
- C. 1
- D. $\frac{\sqrt{3}}{2}$

Answer: C

Solution:

Solution:

When L is removed, the phase difference between the voltage and current is

$$\tan\phi_1 = \frac{X_C}{R}, \tan\frac{\pi}{3} = \frac{X_C}{R} \text{ or } X_C = R \tan 60^\circ \text{ or } X_C = \sqrt{3}R$$

When C is removed, the phase difference between the voltage and current is

$$\tan\phi_2 = \frac{X_L}{R}$$

$$\tan \frac{\pi}{3} = \frac{X_L}{R} \text{ or } X_L = R \tan 60^\circ = \sqrt{3}R$$

As $X_L = X_C$, the series LCR circuit is in resonance.

Impedance of the circuit,

$$Z = \sqrt{R^2 + (X_L - X_C)^2} = R$$

$$(\because X_L = X_C)$$

$$\text{Power factor, } \cos \phi = \frac{R}{Z} = \frac{R}{R} = 1$$

Question 54

The current (I) in the inductance is varying with time according to the plot shown in figure.

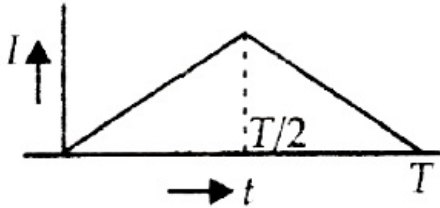

Which one of the following is the correct variation of voltage with time in the coil?

(2012)

Options:

A.

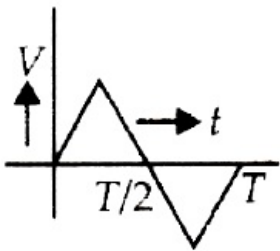

B.

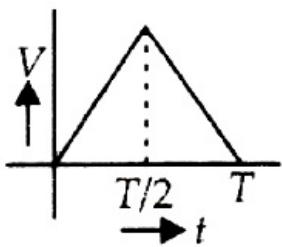

C.

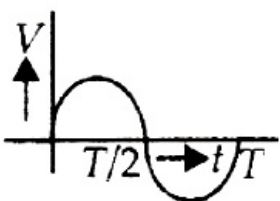

D.

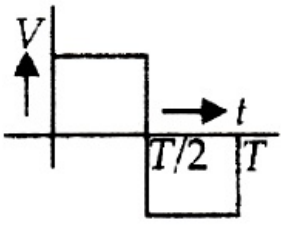

Answer: D

Solution:

Solution:

$$V = -L \frac{dI}{dt}$$

$V \propto$ slope of $I - t$ graph

Question55

The instantaneous values of alternating current and voltages in a circuit are given as

$$i = \frac{1}{\sqrt{2}} \sin(100\pi t) \text{ ampere}$$

$$e = \frac{1}{\sqrt{2}} \sin \left(100\pi t + \frac{\pi}{3} \right) \text{ Volt}$$

The average power in watts consumed in the circuit is
(2012 Mains)

Options:

A. $\frac{1}{4}$

B. $\frac{\sqrt{3}}{4}$

C. $\frac{1}{2}$

D. $\frac{1}{8}$

Answer: D

Solution:

Given: $i = \frac{1}{\sqrt{2}} \sin(100\pi t)$ ampere

Compare it with $i = i_0 \sin(\omega t)$, we get

$$i_0 = \frac{1}{\sqrt{2}} \text{A}$$

Given: $e = \frac{1}{\sqrt{2}} \sin \left(100\pi t + \frac{\pi}{3} \right)$ volt

Compare it with $e = e_0 \sin(\omega t + \phi)$, we get

©



$$e_0 = \frac{1}{\sqrt{2}}V, \phi = \frac{\pi}{3}$$

$$\therefore i_{\text{rms}} = \frac{i_0}{\sqrt{2}} = \frac{\frac{1}{\sqrt{2}}A}{\sqrt{2}} = \frac{1}{2}A e_{\text{rms}} = \frac{e_0}{\sqrt{2}} = \frac{\frac{1}{\sqrt{2}}V}{\sqrt{2}} = \frac{1}{2}V$$

Average power consumed in the circuit,

$$P = i_{\text{rms}} e_{\text{rms}} \cos\phi$$

$$= \left(\frac{1}{2}\right) \left(\frac{1}{2}\right) \cos\frac{\pi}{3} = \left(\frac{1}{2}\right) \left(\frac{1}{2}\right) \left(\frac{1}{2}\right) = \frac{1}{8}W$$

Question56

The primary of a transformer when connected to a dc battery of 10 volt draws a current of 1mA. The number of turns of the primary and secondary windings are 50 and 100 respectively. The voltage in the secondary and the current drawn by the circuit in the secondary are respectively (KN NEET 2013)

Options:

- A. 20V and 2.0mA
- B. 10V and 0.5mA
- C. Zero volt and therefore no current
- D. 20V and 0.5mA

Answer: C

Solution:

Transformer cannot work on dc.

$$\therefore V_s = 0 \text{ and } I_s = 0$$

Question57

A current of 2.5 A flows through a coil of inductance 5H . The magnetic flux linked with the coil is (KN NEET 2013)

Options:

- A. 0.5W b
- B. 12.5W b



C. zero

D. 2W b

Answer: B

Solution:

Here, $I = 2.5 \text{ A}$, $L = 5 \text{ H}$

Magnetic flux linked with the coil is

$$\phi_B = LI = (5 \text{ H})(2.5 \text{ A}) = 12.5 \text{ W b}$$

Question58

In a coil of resistance 10Ω , the induced current developed by changing magnetic flux through it, is shown in figure as a function of time. The magnitude of change in flux through the coil in weber is

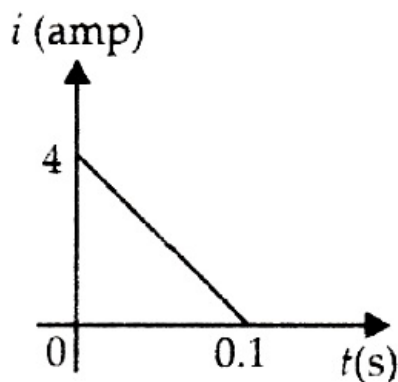

(2012 Mains)

Options:

A. 8

B. 2

C. 6

D. 4

Answer: B

Solution:

$q = \text{Area under } i\text{-}t \text{ graph}$

$$= \frac{1}{2} \times 4 \times 0.1 = 0.2 \text{ C}$$

$$\text{As } q = \frac{\Delta\phi}{R}$$

$$\therefore \Delta\phi = qR = (0.2 \text{ C})(10 \Omega) = 2 \text{ weber}$$

Question59

An ac voltage is applied to a resistance R and an inductor!, in series. If R and the inductive reactance are both equal to 3Ω , the phase difference between the applied voltage and the current in the circuit is (2011)

©

Options:

A. $\frac{\pi}{6}$

B. $\frac{\pi}{4}$

C. $\frac{\pi}{2}$

D. zero

Answer: B

Solution:

Here, $R = 3\Omega$

Inductive reactance, $X_L = 3\Omega$

The phase difference between the applied voltage and the current in the circuit is

$$\tan\phi = \frac{X_L}{R} = \frac{3\Omega}{3\Omega} = 1$$

$$\phi = \tan^{-1} 1 \text{ or } \phi = \frac{\pi}{4}$$

Question60

In an ac circuit, an alternating voltage $e = 200\sqrt{2}\sin 100t$ volts is connected to a capacitor of capacity $1\mu\text{F}$. The r.m.s. value of the current in the circuit is (2011)

©

Options:

A. 10 mA

B. 100 mA

C. 200 mA

D. 20 mA

Answer: D

Solution:



The given equation of alternating voltage is

$$e = 200\sqrt{2}\sin 100t \dots (i)$$

The standard equation of alternating voltage is

$$e = e_0 \sin \omega t \dots (ii)$$

Comparing (i) and (ii), we get

$$e_0 = 200\sqrt{2} \text{ V}, \omega = 100 \text{ rad s}^{-1}$$

The capacitive reactance is

$$X_C = \frac{1}{\omega C} = \frac{1}{100 \times 1 \times 10^{-6}} \Omega$$

The r.m.s. value of the current in the circuit is

$$i_{r.m.s} = \frac{v_{r.m.s}}{X_C} = \frac{\frac{e_0}{\sqrt{2}}}{\omega C} = \frac{\left(\frac{200\sqrt{2}}{\sqrt{2}} \right)}{\left(\frac{1}{100} \times 10^{-6} \right)}$$

$$= 200 \times 100 \times 10^{-6} \text{ A} = 2 \times 10^{-2} \text{ A} = 20 \text{ mA}$$

Question 61

The current i in a coil varies with time as shown in the figure. The variation of induced emf with time would be

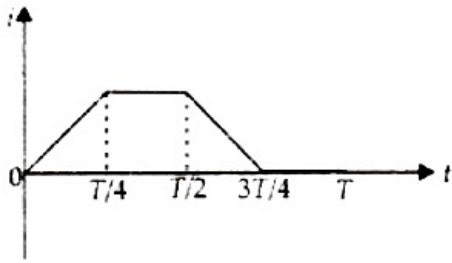

(2011)

Options:

A.

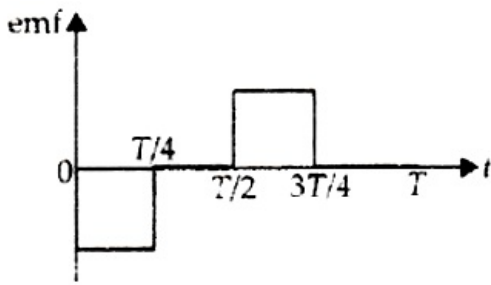

B.

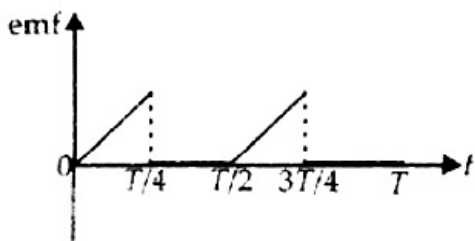

C.

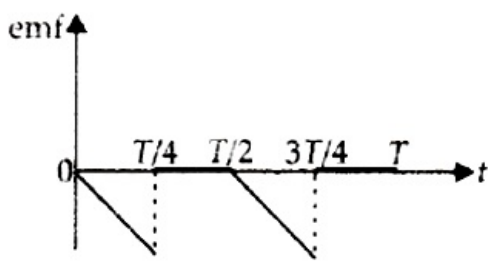

D.

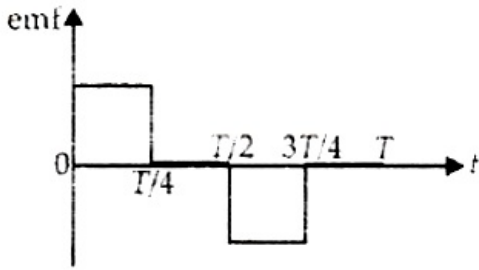

Answer: A

Question 62

The rms value of potential difference V shown in the figure is

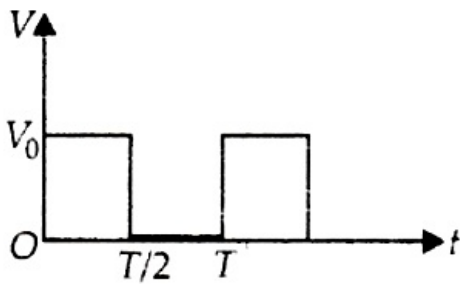

(2011 Mains)

Options:

- A. $\frac{V_0}{\sqrt{3}}$
- B. V_0
- C. $\frac{V_0}{\sqrt{2}}$
- D. $\frac{V_0}{2}$

Answer: C

Solution:

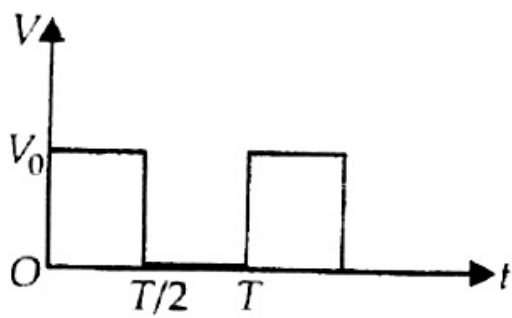

$$V = V_0 \text{ for } 0 \leq t \leq \frac{T}{2}$$

$$V = 0 \text{ for } \frac{T}{2} \leq t \leq T$$

$$V_{rms} = \left[\frac{\int_0^T V^2 dt}{\int_0^T dt} \right] = \left[\frac{\int_0^{\frac{T}{2}} V_0^2 dt + \int_{\frac{T}{2}}^T (0) dt}{\int_0^T dt} \right]$$

$$= \left[V_0^2 \left[t \right]_0^{\frac{T}{2}} \right]^{\frac{1}{2}} = \left[\frac{V_0^2}{T} \left(\frac{T}{2} \right) \right]^{\frac{1}{2}} = \left[\frac{V_0^2}{2} \right]^{\frac{1}{2}}$$

$$V_{rms} = \frac{V_0}{\sqrt{2}}$$

Question 63

A coil has resistance 30 ohm and inductive reactance 20 ohm at 50 Hz frequency. If an ac source, of 200 volt, 100 Hz, is connected across the coil, the current in the coil will be (2011 Mains)

Options:

- A. 2.0 A
- B. 4.0 A
- C. 8.0 A
- D. $\frac{20}{\sqrt{13}}$ A

Answer: B

Solution:

Here Resistance, $R = 30\Omega$

Inductive reactance, $X_L = 20\Omega$ at 50 Hz

$\therefore X_L = 2\pi\nu L$

$$\therefore \frac{X_L}{X'_L} = \frac{v'}{v}$$

$$X'_L + L = \frac{v'}{v} \times X_L = \left(\frac{100}{50}\right) \times 20\Omega = 40\Omega$$

$$\begin{aligned} \text{Impedance, } Z &= \sqrt{R^2 + (X'_L)^2} \\ &= \sqrt{(30)^2 + (40)^2} = 50\Omega \end{aligned}$$

$$\text{Current in the coil, } I = \frac{V}{Z} = \frac{200V}{50\Omega} = 4A$$

Question64

A conducting circular loop is placed in a uniform magnetic field, $B = 0.025 \text{ T}$ with its plane perpendicular to the loop. The radius of the loop is made to shrink at a constant rate of 1 mm s^{-1} . The induced emf when the radius is 2 cm , is (2010)

Options:

A. $2\pi \mu\text{V}$

B. $\pi \mu\text{V}$

C. $\frac{\pi}{2}\mu\text{V}$

D. $2 \mu\text{V}$

Answer: B

Solution:

Here, Magnetic field, $B = 0.025 \text{ T}$

Radius of the loop, $r = 2\text{cm} = 2 \times 10^{-2}\text{m}$

Constant rate at which radius of the loop shrinks,

$$\frac{dr}{dt} = 1 \times 10^{-3}\text{ms}^{-1}$$

Magnetic flux linked with the loop is

$$\phi = BA\cos\theta = B(\pi r^2)\cos 0^\circ = B\pi r^2$$

The magnitude of the induced emf is

$$\begin{aligned} |\varepsilon| &= \frac{d\phi}{dt} = \frac{d}{dt}(B\pi r^2) \frac{dr}{dt} \\ &= 0.025 \times \pi \times 2 \times 2 \times 10^{-2} \times 1 \times 10^{-3} \\ &= \pi \times 10^{-6}\text{V} = \pi\mu\text{V} \end{aligned}$$

Question65

In the given circuit, the reading of voltmeter V_1 and V_2 are 300 volts each. The reading of the voltmeter V_3 and ammeter A are respectively (2010)

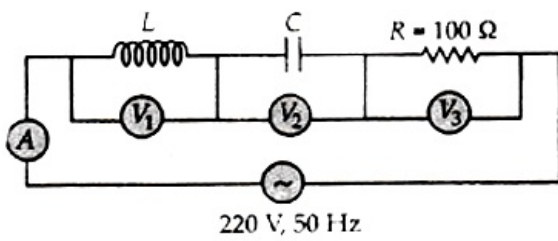

Options:

- A. 150 V, 2.2 A
- B. 220 V, 2.2 A
- C. 220 V, 2.0 A
- D. 100 V, 2.0 A

Answer: B

Solution:

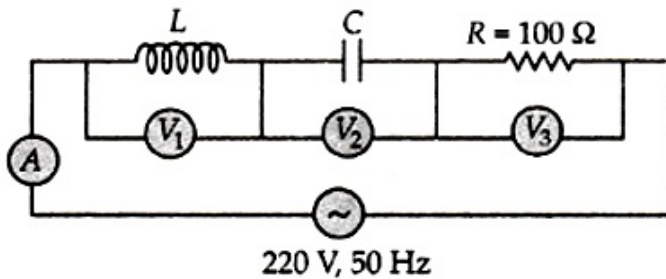

As $V_L = V_C = 300\text{V}$, therefore the given series LCR circuit is in resonance.

$$\therefore V_R = V = 220\text{V}$$

$$Z = R = 100\Omega$$

$$\text{Current, } I = \frac{V}{Z} = \frac{220\text{V}}{100\Omega} = 2.2\text{A}$$

Hence, the reading of the voltmeter V_3 is 220 V and the reading of ammeter A is 2.2 A

Question 66

A 220 volt input is supplied to a transformer. The output circuit draws a current of 2.0 ampere at 440 volts. If the efficiency of the transformer is 80%, the current drawn by the primary windings of the transformer is (2010)

Options:

- A. 3.6 ampere
- B. 2.8 ampere
- C. 2.5 ampere
- D. 5.0 ampere

Answer: D

Solution:

Here, Input voltage, $V_p = 220V$

Output voltage, $V_s = 440V$

Input current, $I_p = ?$

Output current, $I_s = 2A$

Efficiency of the transformer, $\eta = 80\%$

Efficiency of the transformer, $\eta = \frac{\text{output power}}{\text{Input power}}$

$$\eta = \frac{V_s I_s}{V_p I_p}$$

or

$$= 5A I_p = \frac{V_s I_s}{\eta V_p} = \frac{(440V)(2A)}{\left(\frac{80}{100}\right)(220V)} = \frac{(440V)(2A)(100)}{(80)(220V)}$$

Question 67

A condenser of capacity C is charged to a potential difference of V_1 . The plates of the condenser are then connected to an ideal inductor of inductance L. The current through the inductor when the potential difference across the condenser reduces to V_2 is (2010 Mains)

Options:

A. $\left(\frac{C(V_1 - V_2)^2}{L}\right)^{\frac{1}{2}}$

B. $\frac{C(V_1^2 - V_2^2)}{L}$

C. $\frac{C(V_1^2 + V_2^2)}{L}$

D. $\left(\frac{C(V_1^2 - V_2^2)}{L}\right)^{\frac{1}{2}}$

Answer: D

Solution:

In case of oscillatory discharge of a capacitor through an inductor, charge at instant t is given by

$$q = q_0 \cos \omega t$$

Where, $\omega = \frac{1}{\sqrt{LC}}$

$$\therefore \cos \omega t = \frac{q}{q_0} = \frac{CV_2}{CV_1} = \frac{V_2}{V_1} \quad (\because q = CV) \dots \dots \dots (i)$$

Current through the inductor

©

$$I = \frac{dq}{dt}(q_0 \cos \omega t) = -q_0 \omega \sin \omega t$$

$$|I| = CV_1 \frac{1}{\sqrt{LC}} [1 - \cos^2 \omega t]^{\frac{1}{2}}$$

$$= V_1 \sqrt{\frac{C}{L}} \left[1 - \left(\frac{V_2}{V_1} \right)^2 \right]^{\frac{1}{2}} = \left[\frac{C(V_1^2 - V_2^2)}{L} \right]^{\frac{1}{2}}$$

(Using (i))

Question 68

A rectangular, a square, a circular and an elliptical loop, all in the (x-y) plane, are moving out of a uniform magnetic field with a constant velocity, $\vec{v} = v\hat{i}$. The magnetic field is directed along the negative z-axis direction. The induced emf, during the passage of these loops, out of the field region, will not remain constant for (2009)

Options:

- A. the circular and the elliptical loops
- B. only the elliptical loop
- C. any of the four loops
- D. the rectangular, circular and elliptical loops

Answer: A

Solution:

Solution:

Once a rectangular loop or a square loop is being drawn out of the field, the rate of cutting the lines of field will be a constant for a square and rectangle, but not for circular or elliptical areas.

Question 69

Power dissipated in an LCR series circuit connected to an A.C. source of emf ε is (2009)

Options:

A. $\frac{\varepsilon^2 \sqrt{R^2 + \left(L\omega - \frac{1}{C\omega} \right)^2}}{R}$

$$B. \frac{\varepsilon^2 \left[R^2 + \left(L\omega - \frac{1}{C\omega} \right)^2 \right]}{R}$$

$$C. \frac{\varepsilon^2 R}{\sqrt{R^2 + \left(L\omega - \frac{1}{C\omega} \right)^2}}$$

$$D. \frac{\varepsilon^2 R}{\left[R^2 + \left(L\omega - \frac{1}{C\omega} \right)^2 \right]}$$

Answer: D

Solution:

Average power, $P = E_{\text{rms}} I_{\text{rms}} \cos\phi$

$$Z = \sqrt{R^2 + (X_L - X_C)^2}, \cos\phi = \frac{R}{Z}$$

$$\text{But } I_{\text{rms}} = \frac{E_{\text{rms}}}{Z} \therefore P = E_{\text{rms}}^2 \cdot \frac{R}{Z^2}$$

$$\therefore P = E_{\text{rms}}^2 \frac{R}{[R^2 + (X_L - X_C)^2]}$$

$$= \frac{\varepsilon^2 R}{\left[R^2 + \left(L\omega - \frac{1}{C\omega} \right)^2 \right]}$$

Question70

A conducting circular loop is placed in a uniform magnetic field 0.04 T with its plane perpendicular to the magnetic field. The radius of the loop starts shrinking at 2 mm/s. The induced emf in the loop when the radius is 2 cm is (2009)

Options:

A. $4.8\pi \mu\text{V}$

B. $0.8\pi \mu\text{V}$

C. $1.6\pi \mu\text{V}$

D. $3.2\pi \mu\text{V}$

Answer: D

Solution:

$$\phi = BA \cos\theta = B(\pi r^2) \cos 0^\circ = B\pi r^2$$

$$|\varepsilon| = \frac{d\phi}{dt} = B\pi(2r) \frac{dr}{dt}$$

$$= 0.04 \times \pi \times (2 \times 2 \times 10^{-2}) \times 2 \times 10^{-3} = 3.2\pi \times 10^{-6} \text{V} = 3.2\pi \mu\text{V}$$

©

Question71

A long solenoid has 500 turns. When a current of 2 ampere is passed through it, the resulting magnetic flux linked with each turn of the solenoid is 4×10^{-3} Wb. The self-inductance of the solenoid is (2008)

Options:

- A. 1.0 henry
- B. 4.0 henry
- C. 2.5 henry
- D. 2.0 henry

Answer: A

Solution:

Here , $N = 500$, $I = 2A$, $L = ?$

Total flux, $\phi = 4 \times 10^{-3} \times 500$, $\phi = LI$

$$\text{or } L = \frac{\phi}{I} = \frac{4 \times 10^{-3} \times 500}{2} = 10^0 = 1H$$

Question72

In an a.c. circuit, the e.m.f (ε) and the current (i) at any instant are given respectively by

$$\varepsilon = E_0 \sin \omega t, \quad i = I_0 \sin(\omega t - \phi)$$

The average power in the circuit over one cycle of a.c. is (2008)

Options:

- A. $\frac{E_0 I_0}{2} \cos \phi$
- B. $E_0 I_0$
- C. $\frac{E_0 I_0}{2}$
- D. $\frac{E_0 I_0}{2} \sin \phi$



Answer: A

Solution:

$$\text{Average power} = \frac{E_0 I_0}{2} \cos \phi$$

Question73

A circular disc of radius 0.2 meter is placed in a uniform magnetic field of induction $\frac{1}{\pi} \left(\frac{\text{Wb}}{\text{m}^2} \right)$ in such a way that its axis makes an angle of 60° with \vec{B} . The magnetic flux linked with the disc is (2008)

Options:

- A. 0.08 Wb
- B. 0.01 Wb
- C. 0.02 Wb
- D. 0.06 Wb

Answer: C

Solution:

$$B = \frac{1}{\pi} \left(\frac{\text{Wb}}{\text{m}^2} \right)$$

Area of the disc normal to B is $\pi R^2 \cos 60^\circ$

Flux = B x Area normal

$$\therefore \text{Flux} = \frac{1}{2} \times 0.04 = 0.02 \text{ Wb}$$

Question74

The primary and secondary coils of a transformer have 50 and 1500 turns respectively. If the magnetic flux ϕ linked with the primary coil is given by $\phi = \phi_0 + 4t$, where ϕ is in webers, t is time in seconds and ϕ_0 is a constant, the output voltage across the secondary coil is (2007)

Options:

- A. 120 volts



B. 220 volts

C. 30 volts

D. 90 volts

Answer: A

Solution:

Given : No. of turns across primary $N_p = 50$

Number of turns across secondary $N_s = 1500$

Magnetic flux linked with primary, $\phi = \phi_0 + 4t$

\therefore Voltage across the primary,

$$V_p = \frac{d\phi}{dt} = \frac{d}{dt}(\phi_0 + 4t) = 4 \text{ volt}$$

$$\text{Also, } \frac{V_s}{V_p} = \frac{N_s}{N_p}$$

$$\therefore V_s = \left(\frac{1500}{50} \right) \times 4 = 120 \text{ V}$$

Question75

A transformer is used to light a 100 W and 110 V lamp from a 220 V mains. If the main current is 0.5 amp, the efficiency of the transformer is approximately (2007)

Options:

A. 50%

B. 90%

C. 10%

D. 30%.

Answer: B

Solution:

Given : Output power $P = 100 \text{ W}$

Voltage across primary $V_p = 220 \text{ V}$

Current in the primary $I_p = 0.5 \text{ A}$

Efficiency of a transformer

$$\eta = \frac{\text{output power}}{\text{input power}} \times 100$$

$$= \frac{P}{V_p I_p} \times 100 = \frac{100}{220 \times 0.5} \times 100 = 90\%$$

©



Question76

What is the value of inductance L for which the current is maximum in a series LCR circuit with $C = 10\mu\text{F}$ and $\omega = 1000 \text{ s}^{-1}$? (2007)

Options:

- A. 1 mH
- B. cannot be calculated unless R is known
- C. 10 mH
- D. 100 mH .

Answer: D

Solution:

Solution:

In series LCR, current is maximum at resonance.

$$\therefore \text{Resonant frequency } \omega = \frac{1}{\sqrt{LC}}$$

$$\therefore \omega^2 = \frac{1}{LC} \text{ or } L = \frac{1}{\omega^2 C}$$

Given $\omega = 1000\text{s}^{-1}$ and $C = 10\mu\text{F}$

$$\therefore L = \frac{1}{1000 \times 1000 \times 10 \times 10^{-6}} = 0.1 \text{ H} = 100 \text{ mH}$$

Question77

A coil of inductive reactance 31Ω has a resistance of 8Ω . It is placed in series with a condenser of capacitive reactance 25Ω . The combination is connected to an a.c. source of 110 V . The power factor of the circuit is (2006)

Options:

- A. 0.33
- B. 0.56
- C. 0.64
- D. 0.80

Answer: D

Solution:

$$X_L = 31\Omega, X_C = 25\Omega, R = 8\Omega$$

Impedance of series LCR is

$$Z = \sqrt{R^2 + (X_L - X_C)^2}$$

$$= \sqrt{8^2 + (31 - 25)^2} = \sqrt{64 + 36} = 10\Omega$$

$$\text{Power factor, } \cos \phi = \frac{R}{Z} = \frac{8}{10} = 0.8$$

Question78

Two coils of self inductance 2 mH and 8 mH are placed so close together that the effective flux in one coil is completely linked with the other. The mutual inductance between these coils is (2006)

Options:

- A. 16 mH
- B. 10 mH
- C. 6 mH
- D. 4 mH

Answer: D

Solution:

Mutual inductance between coils is

$$M = K \sqrt{L_1 L_2}$$

$$\text{or, } M = 1 \sqrt{2 \times 10^{-3} \times 8 \times 10^{-3}} \quad (\because K = 1)$$

$$= 4 \times 10^{-3} = 4\text{mH}$$

Question79

The core of a transformer is laminated because (2006)

Options:

- A. ratio of voltage in primary and secondary may be increased
- B. energy losses due to eddy currents may be minimised
- C. the weight of the transformer may be reduced
- D. rusting of the core may be prevented.



Answer: B

Solution:

Solution:

The core of a transformer is laminated to minimise the energy losses due to eddy currents.

Question80

A transistor-oscillator using a resonant circuit with an inductor L (of negligible resistance) and a capacitor C in series produce oscillations of frequency f . If L is doubled and C is changed to 4C, the frequency will be (2006)

Options:

- A. $\frac{f}{2}$
- B. $\frac{f}{4}$
- C. 8f
- D. $\frac{f}{2\sqrt{2}}$

Answer: D

Solution:

Solution:

$$\text{Frequency of L cossillation} = \frac{1}{2\pi\sqrt{LC}}$$

$$\text{or, } \frac{f_1}{f_2} = \left(\frac{L_2 C_2}{L_1 C_1} \right)^{1/2} = \left(\frac{2L \times 4C}{L \times C} \right)^{1/2} = (8)^{1/2}$$

$$\therefore \frac{f_1}{f_2} = 2\sqrt{2} \Rightarrow f_2 = \frac{f_1}{2\sqrt{2}} \text{ or, } f_2 = \frac{f}{2\sqrt{2}}$$

Question81

In a circuit L, C and R are connected in series with an alternating voltage source of frequency f . The current leads the voltage by 45°. The value of C is (2005)

Options:



A. $\frac{1}{\pi f (2\pi f L - R)}$

B. $\frac{1}{2\pi f (2\pi f L - R)}$

C. $\frac{1}{\pi f (2\pi f L + R)}$

D. $\frac{1}{2\pi f (2\pi f L + R)}$

Answer: D

Solution:

Solution:

$$\tan \phi = \frac{X_C - X_L}{R}$$

$$\tan\left(\frac{\pi}{4}\right) = \frac{\frac{1}{\omega C} - \omega L}{R}$$

$$R = \frac{1}{\omega C} - \omega L$$

$$(R + 2\pi f L) = \frac{1}{2\pi f C} \text{ or } C = \frac{1}{2\pi f (R + 2\pi f L)}$$

Question 82

As a result of change in the magnetic flux linked to the closed loop as shown in the figure, an e.m.f. V volt is induced in the loop. The work done (joule) in taking a charge Q coulomb once along the loop is (2005)



Options:

A. QV

B. $2QV$

C. $\frac{QV}{2}$

D. zero.

Answer: A

Solution:

Question83

A coil of 40 henry inductance is connected in series with a resistance of 8 ohm and the combination is joined to the terminals of a 2 volt battery. The time constant of the circuit is (2004)

Options:

- A. 5 seconds
- B. $\frac{1}{5}$ seconds
- C. 40 seconds
- D. 20 seconds.

Answer: A

Solution:

Solution:

Time constant of LR circuit is $\tau = \frac{L}{R}$.

$\therefore t = 5 \text{ sec}$

Question84

The magnetic flux through a circuit of resistance R changes by an amount $\Delta\phi$ in a time Δt . Then the total quantity of electric charge Q that passes any point in the circuit during the time Δt is represented by (2004)

Options:

- A. $Q = \frac{1}{R} \cdot \frac{\Delta\phi}{\Delta t}$
- B. $Q = \frac{\Delta\phi}{R}$
- C. $Q = \frac{\Delta\phi}{\Delta t}$
- D. $Q = R \cdot \frac{\Delta\phi}{\Delta t}$

Answer: B



Solution:

Induced emf is given by $V = \frac{\Delta\phi}{\Delta t}$

$$\Rightarrow \text{current}(i) = \frac{Q}{\Delta t} = \frac{\Delta\phi}{\Delta t} \times \frac{1}{R}$$

[where Q is total charge in time Δt]

$$\Rightarrow Q = \frac{\Delta\phi}{R}$$

Question85

For a series LCR circuit the power loss aresonance is (2002)

Options:

A. $\frac{V^2}{\left[\omega L - \frac{1}{\omega C}\right]}$

B. $I^2 L \omega$

C. $I^2 R$

D. $\frac{V^2}{C \omega}$

Answer: C

Solution:

The impedance Z of a series LCR circuit is given by, $Z = \sqrt{R^2 + (X_L - X_C)^2}$

where $X_L = \omega L$ and $X_C = \frac{1}{\omega C}$, ω is angular frequency.

At resonance, $X_L = X_C$, hence $Z = R$.

$\therefore V_R = V$ (supply voltage)

$$\therefore \text{R.M.S. current, } I = \frac{V_R}{R} = \frac{V}{R}$$

$$\therefore \text{Power loss} = I^2 R = \frac{V^2}{R}$$

Question86

For a coil having $L = 2 \text{ mH}$, current flow through it is $I = t^2 e^{-t}$ then, the time at which emf becomes zero (2001)

Options:

- A. 2 sec
- B. 1 sec
- C. 4 sec
- D. 3 sec.

Answer: A**Solution:**

$$I = t^2 e^{-t}$$

$$|\varepsilon| = L \frac{dI}{dt} \text{ here emf is zero when } \frac{dI}{dt} = 0$$

$$\frac{dI}{dt} = 2te^{-t} - t^2 e^{-t} = 0; 2te^{-t} = t^2 e^{-t}$$

$$\text{i.e., } te^{-t}(t - 2) = 0 \Rightarrow t \neq \infty \text{ and } t \neq 0$$

$$\therefore t = 2 \text{ sec.}$$

Question87

A capacitor of capacity C has reactance X . If capacitance and frequency become double then reactance will be (2001)

Options:

- A. 4X
- B. $\frac{X}{2}$
- C. $\frac{X}{4}$
- D. 2X .

Answer: C**Solution:**

$$X = \frac{1}{C\omega} \quad X' = \frac{1}{4C\omega}$$

$$\therefore X' = \frac{X}{4}$$

Question88

The value of quality factor is (2000)

Options:

- A. $\frac{\omega L}{R}$
- B. $\frac{1}{\omega RC}$
- C. \sqrt{LC}
- D. $\frac{L}{R}$

Answer: B

Solution:

Quality factor $Q = \frac{\omega L}{R}$

since $\omega^2 = \frac{1}{LC}$

\therefore Quality factor $Q = \frac{1}{\omega RC}$

Question89

In the circuit given in figure, 1 and are ammeters. Just after key K is pressed to complete the circuit, the reading will be (1999)

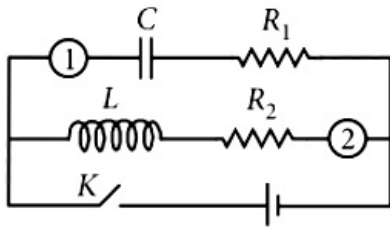

Options:

- A. zero in 1, maximum in 2
- B. maximum in both 1 and 2
- C. zero in both 1 and 2
- D. maximum in 1, zero in 2.

Answer: D

Solution:

At $t = 0$

(i) capacitor offers negligible resistance.

(ii) inductor offers large resistance to current flow.

Question90

A step-up transformer operates on a 230 V line and supplies a load of 2 ampere. The ratio of the primary and secondary windings is 1 : 25. The current in the primary is (1998)

Options:

- A. 15 A
- B. 50 A
- C. 25 A
- D. 12.5 A

Answer: B

Solution:

$$\frac{E_P}{E_S} = \frac{N_P}{N_S} = \frac{1}{25}; E_S = 5750 \text{ V}$$

$$I_S = 2 \text{ amp}, P_S = 2 \times 5750$$

$$I_P = \frac{P_P}{V_P} = \frac{P_S}{V_P} = \frac{2 \times 5750}{230} = 50 \text{ A}$$

Question91

Two coils have a mutual inductance 0.005 H . The current changes in the first coil according to equation $I = I_0 \sin \omega t$ where $I_0 = 10 \text{ A}$ and $\omega = 100\pi \text{ rad / sec}$. The maximum value of e.m.f. in the second coil is (1998)

Options:

- A. π
- B. 5π
- C. 2π
- D. 4π .



Answer: B

Solution:

$$\begin{aligned} \text{As, } |\varepsilon| &= M \frac{dI}{dt} \\ &= M \frac{d}{dt}(I_0 \sin \omega t) = M I_0 \omega \cos \omega t \\ \therefore \varepsilon_{\max} &= 0.005 \times 10 \times 100\pi \times 1 = 5\pi \end{aligned}$$

Question92

The primary winding of a transformer has 500 turns whereas its secondary has 5000 turns. The primary is connected to an A.C. supply of 20V, 50H z. The secondary will have an output of (1997)

Options:

- A. 2V, 50H z
- B. 2V, 5H z
- C. 200V, 50H z
- D. 200V, 500H z.

Answer: C

Solution:

Solution:

Turns on primary winding = 500; Turns on secondary winding = 5000; Primary winding voltage (E_p) = 20V and frequency = 50 H z.

$$\frac{N_s}{N_p} = \frac{E_s}{E_p} \text{ or } \frac{5000}{500} = \frac{E_s}{20}$$

$$\text{or } E_s = \frac{5000 \times 20}{500} = 200V$$

and frequency remains the same. Therefore secondary winding will have an output of 200V, 50 H z

Question93

In an a.c. circuit with phase voltage V and current I, the power dissipated is (1997)

Options:



A. $V \cdot I$

B. depends on phase angle between V and I

C. $\frac{1}{2} \times V \cdot I$

D. $\frac{1}{\sqrt{2}} \times V \cdot I$

Answer: B

Solution:

Solution:

The dissipation of power in an a.c. circuit is $(P) = V \times I \times \cos \theta$. Therefore current flowing in the circuit depends upon the phase angle between voltage (V) and current (I) of the a.c. circuit.

Question94

A metal ring is held horizontally and bar magnet is dropped through the ring with its length along the axis of the ring. The acceleration of the falling magnet is (1996)

Options:

A. more than g

B. equal to g

C. less than g

D. either(a) or (c).

Answer: C

Solution:

Solution:

When the magnet is dropped through the ring, an induced current is developed into the ring in the direction opposing the motion of magnet (Lenz's law). Therefore this induced current decreases the acceleration of bar magnet.

Question95

In an A.C. circuit, the current flowing is $I = 5 \sin \left(100t - \frac{\pi}{2} \right)$ ampere and the potential difference is $V = 200 \sin(100t)$ volts. The power consumption is equal to (1995)



Options:

- A. 20 W
- B. 0 W
- C. 1000 W
- D. 40 W .

Answer: B**Solution:****Solution:**

Current (I) = $5 \sin\left(100t - \frac{\pi}{2}\right)$ and voltage (V) = $200 \sin(100t)$. Comparing the given equation, with the standard equation, we find that phase between current and voltage is

$$\phi = \frac{\pi}{2} = 90^\circ$$

$$\begin{aligned} \text{Power consumption } P &= I_{\text{rms}} V_{\text{rms}} \cos \phi \\ &= I_{\text{rms}} V_{\text{rms}} \cos 90^\circ = 0 \end{aligned}$$

Question96

When the key K is pressed at time $t = 0$, then which of the following statement about the current I in the resistor AB of the given circuit is true?

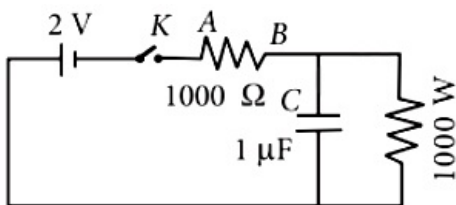
(1995)**Options:**

- A. I oscillates between 1 mA and 2 mA
- B. at $t = 0$, $I = 2$ mA and with time it goes to 1 mA
- C. $I = 1$ mA at all
- D. $I = 2$ mA at all t

Answer: B**Solution:**

Initially, the current will pass through the capacitor (and not through the resistance which is parallel to the capacitor). So effective resistance in the circuit is R_{AB} . Therefore the current in the resistor is 2 mA. After some time, the capacitor will become fully charged and will be in its steady state. Now no current will pass through the capacitor and the effective

resistance of the circuit will be
 $(1000 + 1000) = 2000\Omega$
 Therefore current in the resistor
 $= \frac{V}{R} = \frac{2}{2000} = 1 \times 10^{-3} \text{ A} = 1 \text{ mA}$

Question97

The current I in an A.C. circuit with inductance coil varies with time according to the graph given below.

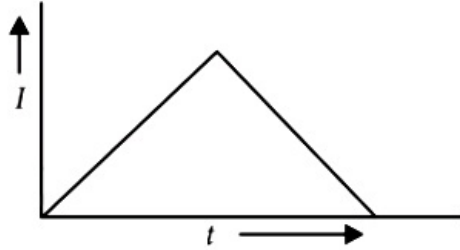

Which one of the following graphs gives the variation of voltage with time?
 (1994)

Options:

A.

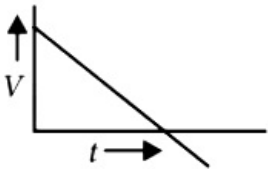

B.

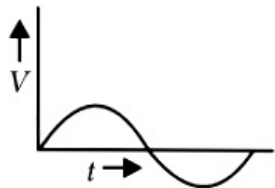

C.

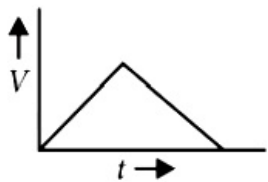

D.

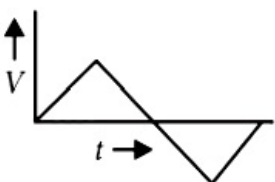

Answer: A

Solution:

In an A.C. circuit with inductance coil, the voltage V leads the current I by a phase difference of 90° . Or the current I lags behind the voltage V by a phase difference of 90° . Thus the voltage goes on decreasing with the increase in time as shown in the graph (a).

Question98

A straight line conductor of length 0.4 m is moved with a speed of 7 m / s perpendicular to a magnetic field of intensity 0.9 W b / m². The induced e.m.f. across the conductor is (1995)

Options:

- A. 5.04 V
- B. 25.2 V
- C. 1.26 V
- D. 2.52 V .

Answer: D

Solution:

Length of conductor (l) = 0.4 m;

Speed = 7 m / s

and magnetic field (B) = 0.9 W b / m²

Induced e.m.f. (ϵ) = $Blv = 0.9 \times 0.4 \times 7 = 2.52$ V

Question99

In an A.C. circuit, I_{rms} and I_0 are related as (1994)

Options:

A. $I_{\text{rms}} = \pi I_0$

B. $I_{\text{rms}} = \sqrt{2} I_0$

C. $I_{\text{rms}} = \frac{I_0}{\pi}$

D. $I_{\text{rms}} = \frac{I_0}{\sqrt{2}}$

Answer: D

Solution:

$$I_{\text{rms}} = \frac{I_0}{\sqrt{2}}$$

Question100

An series L – C – R circuit is connected to a source of A.C. current. At resonance, the phase difference between the applied voltage and the current in the circuit, is (1994)

Options:

A. π

B. zero

C. $\frac{\pi}{4}$

D. $\frac{\pi}{2}$.

Answer: B

Solution:

Solution:

For resonance condition, the impedance will be minimum and the current will be maximum. This is only possible when $X_L = X_C$

$$\text{Therefore } \tan \theta = \frac{X_L + X_C}{R} = 0 \text{ or } \theta = 0$$

Question101

Two cables of copper are of equal lengths. One of them has a single wire of area of cross-section A, while other has 10 wires of cross-sectional area $\frac{A}{10}$ each. Give their suitability for transporting A.C. and D.C. (1994)

Options:

- A. only multiple strands for A.C., either for D.C.
- B. only multiple strands for A.C., only single strand for D.C.
- C. only single strand for D.C., either for A.C.
- D. only single strand for A.C., either for D.C.

Answer: A

Solution:

Solution:

The major portion of the A.C. flows on the surface of the wire. So where a thick wire is required, a number of thin wires are joined together to give an equivalent effect of a thick wire. Therefore multiple strands are suitable for transporting A.C. Similarly multiple strands can also be used for D.C.

Question102

If N is the number of turns in a coil, the value of self inductance varies as (1993)

Options:

- A. N^0
- B. N
- C. N^2
- D. N^{-2}

Answer: C

Solution:

$$L = \frac{N \phi}{i}; \phi = BA; B = \mu_0 n i = \frac{\mu_0 N i}{l}$$

$$L = \frac{\mu_0 N^2}{l} A = \mu_0 n^2 A l$$

where n is the number of turns/unit length $L \propto N^2$

Question103

What is the self-inductance of a coil which produces 5 V when the current changes from 3 ampere to 2 ampere in one millisecond? (1993)

Options:

- A. 5000 henry
- B. 5 milli-henry
- C. 50 henry
- D. 5 henry

Answer: B

Solution:

$$\varepsilon = -L \frac{di}{dt}$$
$$L = \frac{-\varepsilon}{\frac{di}{dt}} = \frac{-5 \times 10^{-3}}{(2-3)} \text{H} = 5 \text{ mH}$$

Question104

The time constant of C – R circuit is (1992)

Options:

- A. $\frac{1}{CR}$
- B. $\frac{C}{R}$
- C. CR
- D. $\frac{R}{C}$

Answer: C

Solution:

Solution:

The time constant for resonance circuit, $\tau = CR$

Growth of charge in a circuit containing capacitance and resistance is given by the formula,

$$q = q_0(1 - e^{-t/CR})$$

CR is known as time constant in this formula.

Question105

The total charge, induced in a conducting loop when it is moved in magnetic field depends on



(1992)

©

Options:

- A. the rate of change of magnetic flux
- B. initial magnetic flux only
- C. the total change in magnetic flux
- D. final magnetic flux only

Answer: C

Solution:

$$q = \int i dt = \frac{1}{R} \int \varepsilon dt = \left(\frac{-d\phi}{dt} \right) \frac{1}{R} \int dt = \frac{1}{R} \int d\phi$$

Hence total charge induced in the conducting loop depend upon the total change in magnetic flux. As the emf or iR depends on rate of change of ϕ , charge induced depends on change of flux.

Question106

A rectangular coil of 20 turns and area of cross-section 25 sq. cm has a resistance of 100Ω . If a magnetic field which is perpendicular to the plane of coil changes at a rate of 1000 tesla per second, the current in the coil is
(1992)

©

Options:

- A. 1 A
- B. 50 A
- C. 0.5 A
- D. 5 A

Answer: C

Solution:

$$i = \frac{\varepsilon}{R} = \frac{N A dB}{R dt} \\ = \frac{20 \times (25 \times 10^{-4}) \times 1000}{100} = 0.5 \text{ A}$$



Question107

Faraday's laws are consequence of conservation of (1991)

Options:

- A. energy
- B. energy and magnetic field
- C. charge
- D. magnetic field

Answer: A

Solution:

Solution:

According to Faraday's laws, it is the conservation of energy.

Question108

If the number of turns per unit length of a coil of solenoid is doubled, the self-inductance of the solenoid will (1991)

Options:

- A. remain unchanged
- B. be halved
- C. be doubled
- D. become four times

Answer: D

Solution:

Self inductance of a solenoid = $\mu_0 n^2 Al$

where n is the number of turns/length.

So self induction $\propto n^2$

So inductance becomes 4 times when n is doubled.

Question109



A 100 millihenry coil carries a current of 1A. Energy stored in its magnetic field is (1991)

Options:

- A. 0.5 J
- B. 1 A
- C. 0.05 J
- D. 0.1 J

Answer: C

Solution:

$$E = \frac{1}{2}Li^2 = \frac{1}{2} (100 \times 10^{-3}) \times 1^2 = 0.05\text{J}$$

Question 110

A magnetic field of 2×10^{-2} T acts at right angles to a coil of area 100 cm^2 , with 50 turns. The average e.m.f. induced in the coil is 0.1 V, when it is removed from the field in t sec. The value of t is (1991)

Options:

- A. 10 s
- B. 0.1 s
- C. 0.01 s
- D. 1 s

Answer: B

Solution:

$$\varepsilon = \frac{-(\phi_2 - \phi_1)}{t} = \frac{-(0 - NBA)}{t} = \frac{NBA}{t}$$
$$t = \frac{NBA}{\varepsilon} = \frac{50 \times 2 \times 10^{-2} \times 10^{-2}}{0.1} = 0.1\text{s}$$

Question111

The current in self inductance $L = 40 \text{ mH}$ is to be increased uniformly from 1 amp to 11 amp in 4 milliseconds. The e.m.f. induced in inductor during process is (1990)

Options:

- A. 100 volt
- B. 0.4 volt
- C. 4.0 volt
- D. 440 volt

Answer: A

Solution:

$$|\varepsilon| = L \frac{di}{dt}$$

Given that, $L = 40 \times 10^{-3} \text{ H}$,

$di = 11 \text{ A} - 1 \text{ A} = 10 \text{ A}$

and $dt = 4 \times 10^{-3} \text{ s}$

$$\therefore |\varepsilon| = 40 \times 10^{-3} \times \left(\frac{10}{4 \times 10^{-3}} \right) = 100 \text{ V}$$

Question112

An inductor may store energy in (1990)

Options:

- A. its electric field
- B. its coils
- C. its magnetic field
- D. both in electric and magnetic fields

Answer: C



Question113

In a region of magnetic induction $B = 10^{-2}$ tesla, a circular coil of radius 30 cm and resistance π^2 ohm is rotated about an axis which is perpendicular to the direction of B and which forms a diameter of the coil. If the coil rotates at 200 rpm the amplitude of the alternating current induced in the coil is (1988)

Options:

- A. $4\pi^2$ mA
- B. 30 mA
- C. 6 mA
- D. 200 mA

Answer: C

Solution:

$$I_0 = \frac{E_0}{R} = N \frac{BA\omega}{R}$$

Given, $N = 1$, $B = 10^{-2}$ T

$A = \pi(0.3)^2 \text{m}^2$, $R = \pi^2$

$f = \left(\frac{200}{60}\right)$ and $\omega = 2\pi\left(\frac{200}{60}\right)$

Substituting these values and solving, we get

$$I_0 = 6 \times 10^{-3} \text{A} = 6 \text{ mA}$$

Question114

Eddy currents are produced when (1988)

Options:

- A. a metal is kept in varying magnetic field
- B. a metal is kept in steady magnetic field
- C. a circular coil is placed in a magnetic field
- D. through a circular coil, current is passed

Answer: A

Solution:

Eddy currents are produced when a metal is kept in a varying magnetic field.

